

Tel Örgü Kablo Kanalları

Mesh Wire Cable Trays

Sipariş No (Order Number)	a (mm)	h (mm)	s (mm)	Ağırlığı (Weight) Kg / Mt
AFC - 35 TEL 50 .40	50	35	4.0	0.515
AFC - 35 TEL 100 .40	100	35	4.0	0.565
AFC - 35 TEL 150 .40	150	35	4.0	0.720
AFC - 35 TEL 200 .40	200	35	4.0	0.870
AFC - 35 TEL 250 .40	250	35	4.0	1.025
AFC - 35 TEL 300 .40	300	35	4.0	1.175
AFC - 60 TEL 100 .40	100	60	4.0	0.820
AFC - 60 TEL 150 .40	150	60	4.0	0.970
AFC - 60 TEL 200 .40	200	60	4.0	1.125
AFC - 60 TEL 250 .40	250	60	4.0	1.280
AFC - 60 TEL 300 .40	300	60	4.0	1.430
AFC - 60 TEL 400 .40	400	60	4.0	1.735
AFC - 60 TEL 500 .40	500	60	4.0	2.040
AFC - 60 TEL 600 .40	600	60	4.0	2.350
AFC - 85 TEL 100 .40	100	85	4.0	0.870
AFC - 85 TEL 150 .40	150	85	4.0	1.025
AFC - 85 TEL 200 .40	200	85	4.0	1.175
AFC - 85 TEL 250 .40	250	85	4.0	1.330
AFC - 85 TEL 300 .40	300	85	4.0	1.480
AFC - 85 TEL 400 .40	400	85	4.0	1.790
AFC - 85 TEL 500 .40	500	85	4.0	2.095
AFC - 85 TEL 600 .40	600	85	4.0	2.400
AFC - 110 TEL 200 .40	200	110	4.0	1.430
AFC - 110 TEL 250 .40	250	110	4.0	1.585
AFC - 110 TEL 300 .40	300	110	4.0	1.735
AFC - 110 TEL 400 .40	400	110	4.0	2.040
AFC - 110 TEL 500 .40	500	110	4.0	2.350
AFC - 110 TEL 600 .40	600	110	4.0	2.655

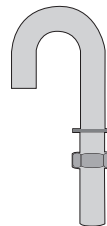
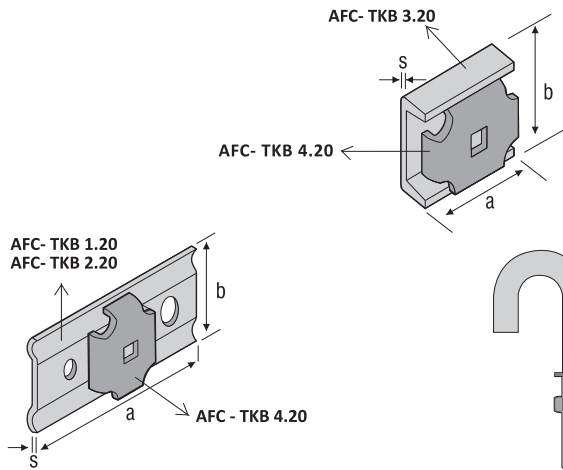
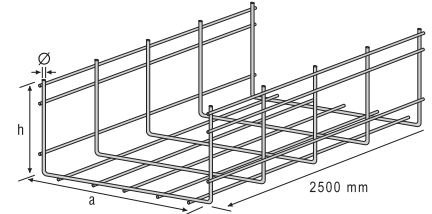
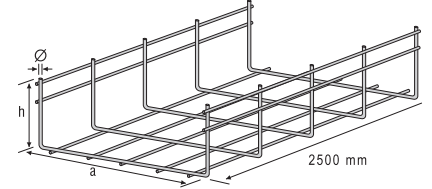
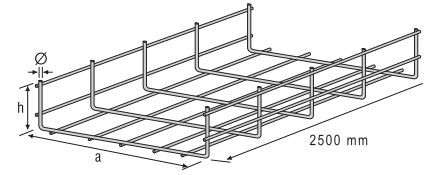
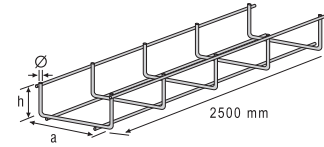
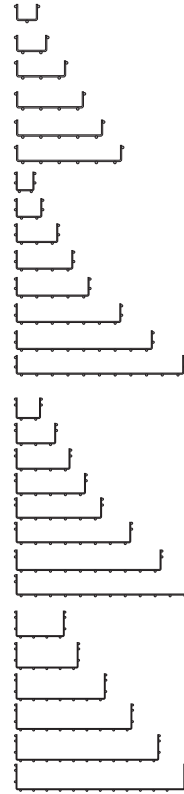

AFC-JK 40.60

Tel Kanal Birleştirme Elemanları
Wire Canal Connector Unit

Sipariş No (Order Number)	R (mm)
AFC - TKB 1 . 20	2.0
AFC - TKB 2 . 20	2.0
AFC - TKB 3 . 20	2.0
AFC - TKB 4 . 20	2.0
AFC - JK 40 . 60	6.0

Uygulama Prosesi
Mounting Examples

